

# 78102

## HEROES BRICKS ROBOT



Fabbricato e importato da:  
Manufactured and imporeted by  
Fabricado e importado por:  
Fabricado e importado por:  
Fabriqué et importé par:  
Hergestellt und importiert von:



NICE SRL  
a Salgari 10, 41123 Modena – Ita



**NICE s.r.l.**

Via Emilio Salgari 10-41123 Modena - Italia  
Tel. +39 059 330985 Fax +39 059 8672379  
P.I. (VAT) IT02326080369 - REA 281775  
Cap. Sociale € 15.000,00 interamente versato  
amministrazione@nicegroup.it



**DICHIARAZIONE CE DI CONFORMITÀ - EC DECLARATION OF CONFORMITY  
DECLARACIÓN CE DE CONFORMIDAD - DÉCLARATION CE DE CONFORMITÉ**

N. ... (identificazione unica del giocattolo/dei giocattoli) - No ... (unique identification of the toy/toys)NO  
No ... (identificación única del juguete o los juguetes) - No ... (identification unique du ou des jouetes)

**78102**

Nome ed indirizzo del fabbricante o del suo rappresentante autorizzato - Name and address of the manufacturer or his authorised representative  
Nombre y dirección del fabricante o de su representante autorizado - Nom et adresse du fabricant ou de son mandataire

**Nice srl - Via Salgari, 10 - 41123 Modena (MO) - Italy**

La presente dichiarazione di conformità è rilasciata sotto l'esclusiva responsabilità del fabbricante  
This declaration of conformity is issued under the sole responsibility of the manufacturer  
La presente declaración de conformidad se expide bajo la exclusiva responsabilidad del fabricante  
La présente déclaration de conformité est établie sous la seule responsabilité du fabricant

**Nice srl - Via Salgari, 10 - 41123 Modena (MO) - Italy**

Oggetto della dichiarazione - Object of the declaration  
Objeto de la declaración - Objet de la déclaration

Name	Description	Photo
<b>78102</b>	<b>HEROES BRICKS ROBOT</b>	

L'oggetto della dichiarazione è conforme alla pertinente normativa comunitaria di armonizzazione  
The object of the declaration described is in conformity with relevant Community harmonisation legislation  
El objeto de la declaración es conforme a la legislación comunitaria de armonización pertinente  
L'objet de la déclaration est conforme à la législation communautaire d'harmonisation applicable

**DIRECTIVE 2009/48/EC SAFETY OF TOYS 2014/30/EU**

Riferimento alle pertinenti norme armonizzate utilizzare o alle specifiche in relazione alle quali viene dichiarata la conformità  
Referencese to the relevant harmonised standards used, or reference to the specifications in relation to which conformity is declared  
Referencias a las normas armonizadas aplicadas o referencias a las especificaciones respecto a las cuales se declara la conformidad  
Références des normes harmonisées pertinentes appliquées ou des spécifications par rapport auxquelles la conformité est déclarée

**EN 71-1: 2014 + A1: 2018**

**EN 71-2: 2020**

**EN 71-3: 2019 + A1 : 2021**

Ulteriori informazioni - Additional information  
Información adicional - Informations complémentaires

**REGULATION 1907/2006/EC REACH**

Luogo e data di emissione - Place and date of issue  
Lugar y fecha de expedición - Date et lieu d'établissement

Firmato a nome e per conto di - Signed for and on behalf of  
Firmado por y en nombre de - Signé par et au nom de

**Modena, 15/03/2023**

**Marco Gianasi, CEO**

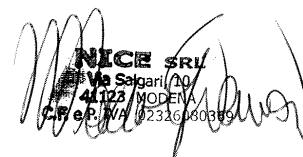
  
NICE SRL  
Via Salgari, 10  
41123 MODENA  
C.F. e P. IVA 02326080369

**HEROES.  
BRICKS.**



**HEROES.  
BRICKS.**



**HEROES.  
BRICKS.**

**6+**



**78102**



**234  
PCS**

**78102**

**NICE  
MATTONCINI**

**HEROES.  
BRICKS.**

**HEROES.  
BRICKS.**



**SCOPRI TUTTI I PRODOTTI  
NICE MATTONCINI**



**78102**

**SERVIZIO CLIENTI  
www.nicogroup.it**

**NICE  
GROUP**

**DESIGNED IN ITALY**



Attenzione: questo prodotto è destinato ai bambini di età superiore ai 6 anni. È vietato il consumo di questo prodotto. Il prodotto è costituito da piccoli pezzi che possono essere ingeriti. È vietato l'uso del prodotto come arma. È vietato l'uso del prodotto per scopi non previsti. È vietato l'uso del prodotto in ambienti dove sono vietati i giocattoli. È vietato l'uso del prodotto in ambienti dove sono vietati i giocattoli.



I) Fabbricato e importato da: Nice S.r.l., Via E. Salgari 10 - 41123 Modena - Italy. info@nicegroup.it Siraccommenda di conservare il nostro indirizzo per qualsiasi informazione. I colori e i dettagli del contenuto possono variare da quanto illustrato. ATTENZIONE! Non adatto ai bambini di età inferiore ai 3 anni in quanto contiene piccole parti che potrebbero essere ingerite. Rischio di soffocamento. Per la sicurezza del bambino eliminare le parti utilizzate per fissare il contenuto dell'imballo. Conservare l'imballo per futura referenza in quanto contiene informazioni importanti. Utilizzare sotto la diretta sorveglianza di un adulto, un errato utilizzo del giocopuò essere causato pericolo. Prima di iniziare il gioco, leggere le istruzioni di uso e manutenzione. Seguirle e conservarle. La mancata osservanza può esporre a pericolo. Tenere fuori dalla portata dei bambini molto piccoli. ATTENZIONE! Adatto per bambini dai 5 anni di età e oltre. Made in China. Printed in China.

GB) Manufactured & imported by: Nice S.r.l., Via E. Salgari 10 - 41123 Modena - Italy. info@nicegroup.it Please retain company details for further reference. Colours and contents may vary from those shown. WARNING! Not suitable for children under 3 years because of small parts. Choking hazard. For the child's safety please remove the parts used to fix the contents. The packaging contains important information. Please keep for future reference. Only use under direct supervision of an adult, incorrect use can be dangerous. Read carefully instructions for use and maintenance before starting. Retain them. Failure to comply can expose to danger. Keep out of young children's reach. WARNING! Only for children 5 years and over. Made in China. Printed in China.

E) Fabricado y importado por: Nice S.r.l., Via Salgari 10 - 41123 Modena - Italy. info@nicegroup.it Se recomienda conservar nuestra dirección para cualquier información. Los colores y los detalles del contenido pueden variar con respecto a lo ilustrado. ¡ATENCIÓN! No adecuado para niños de edad inferior a 3 años, a causa de pequeñas piezas que podrían ser ingeridas. Peligro de asfixia. Para la seguridad del niño, elimine las partes utilizadas para fijar el contenido del embalaje. Conserve el embalaje para futuras referencias, ya que contiene información importante. Utilizar bajo la vigilancia de un adulto, un uso erróneo del juego puede ser causa de peligro. Lea cuidadosamente las instrucciones de uso y mantenimiento antes de comenzar. Retenerlas. El incumplimiento puede exponer al peligro. Mantener fuera del alcance de los niños muy pequeños. ¡ATENCIÓN! Adecuado para niños mayores de 5 años. Fabricado en China. Impreso en China.

FR) Fabriqué et importé par: Nice S.r.l., Via E. Salgari 10 - 41123 Modena, Italy. info@nicegroup.it Nous vous conseillons de conserver nos coordonnées pour future référence. Les couleurs et les détails du contenu peuvent être différents de ce qui est illustré. ATTENTION! Ne convient pas aux enfants de moins de 3 ans à cause des petites pièces qui pourraient être avalées. Danger d'étouffement. Pour la sécurité de l'enfant, enlever les attaches et l'emballage du jouet avant de le donner à l'enfant. Étant donné qu'il y a des informations importantes sur l'emballage conservez-les pour les consulter par la suite. À utiliser sous la surveillance d'un adulte. Une utilisation inappropriée peut être dangereuse. Lire attentivement les instructions pour l'utilisation et l'entretien avant de commencer. Conservez-les. Le non-respect peut exposer au danger. Conserver hors de la portée des enfants en bas âge. ATTENTION! Convient aux enfants de 5 ans et plus. Fabriqué en Chine. Imprimé en Chine.

P) Fabricado e importado por: Nice S.r.l., Via E. Salgari 10 - 41123 Modena, Italy. info@nicegroup.it Recomendamos guardar o nosso endereço para qualquer informação adicional. As cores e os detalhes do conteúdo podem variar da imagem mostrada. ATENÇÃO! Não é recomendado para crianças menores de 3 anos por conter partes pequenas que podem ser engolidas. Perigo de asfixia. Para a segurança das crianças, elimine as partes utilizadas para fixar o conteúdo da embalagem. Utilizar sob a vigilância de um adulto. O uso indevido do brinquedo pode ser causa de perigo. Manter fora do alcance de crianças muito pequenas. ATENÇÃO! Recomendado para crianças maiores de 5 anos de idade. Fabricado na China. Impresso na China.

D) Hergestellt und importiert von: Nice S.r.l., Via E. Salgari 10 - 41123 Modena, Italien. info@nicegroup.it Für Informationen, Adresse bitte aufbewahren. Farben und Inhalt können von der Abbildung abweichen. ACHTUNG! Enthält Kleinteile, die verschluckt werden können. Nicht für Kinder unter 3 Jahre geeignet. Erstickungsgefahr. Für die Sicherheit Ihres Kindes, alle Verpackungsbestandteile entfernen. Verpackung enthält wichtige Informationen, bitte aufbewahren. Nur unter Aufsicht Erwachsener verwenden. Unsachgemäße Verwendung kann gefährlich sein. Vor Gebrauch Anleitung und Aufbewahrungshinweise sorgfältig durchlesen. Hinweise aufbewahren. ACHTUNG! Von Kleinkindern fernhalten. Nur für Kinder ab 5 Jahre. Hergestellt in China. Gedruckt in China.

INFORMAZIONI DI SICUREZZA SULL'UTILIZZO DELLE SOSTANZE! Conservare in luogo fresco al riparo dalla luce, max 30°C. Solo per uso esterno. Evitare il contatto con occhi, non ingerire. In caso di contatto con gli occhi, lavare abbondantemente con acqua, tenendo, se necessario gli occhi aperti. Consultare immediatamente un medico. In caso d'ingestione, risciacquare abbondantemente la bocca con acqua. Bere dell'acqua fresca. NON PROVOCARE IL VOMITO. Consultare immediatamente un medico. In caso di arrossamento o prurito interrompere l'uso e lavare accuratamente con acqua. Se l'irritazione persiste consultare un medico. SAFETY INFORMATION ABOUT USE OF THE SUBSTANCES! Keep in a cool place (max. 30°C) away from the light. For external use only. Avoid contact with the eyes, do not swallow. In case of contact with the eyes, wash with plenty of water while keeping the eyes open if necessary. Seek medical assistance immediately. If swallowed, rinse the mouth with plenty of water. Drink fresh water. DO NOT INDUCE VOMITING. Seek medical assistance immediately. If rash or irritation occur, discontinue use and wash thoroughly with water. Seek medical assistance if irritation persists. ¡INFORMACIONES DE SEGURIDAD SOBRE EL USO DE LAS SUSTANCIAS! Conservar en un lugar fresco al resguardo de la luz, a máx. 30°C. Solo para uso externo. Evitar el contacto con los ojos, no ingerir. En caso de contacto con los ojos, lavar con abundante agua manteniendo, si fuese necesario, los ojos abiertos. Consultar inmediatamente al médico. En caso de ingestión, hacer buches con abundante agua. Beber agua fresca. NO PROVOCAR EL VÓMITO. Consultar de inmediato un médico. En caso de enrojecimiento o de prurito, interrumpir el uso y lavar con mucha agua. Si la irritación persiste, consultar un médico. INFORMAÇÕES DE SEGURANÇA SOBRE A UTILIZAÇÃO DAS SUBSTÂNCIAS! Conservar em local fresco ao abrigo da luz, a uma temperatura máxima de 30°C. Apenas para uso externo. Evitar o contacto com os olhos, não ingerir. Em caso de contacto com os olhos, lavar com água abundante mantendo os olhos abertos, se necessário. Consultar imediatamente um médico. Em caso de ingestão, lavar a boca com água abundante. Beber água fresca. NÃO PROVOCAR O VÓMITO. Consultar imediatamente um médico. Em caso de vermelhidão ou prurido interromper o uso e lavar cuidadosamente com água. Se a irritação persistir, consultar um médico. INFORMATIONS DE SECURITES URL'UTILISATION DES SUBSTANCES! Conserver dans un endroit frais, à l'abri de la lumière, à une température ne dépassant pas 30°C. Usage extérieur seulement. Eviter le contact avec les yeux, ne pas ingérer. En cas de contact avec les yeux, laver abondamment avec de l'eau en tenant, si nécessaire, les paupières ouvertes. Consulter immédiatement un médecin. En cas d'ingestion, rincer la bouche abondamment avec de l'eau. Boire de l'eau fraîche. NE PAS FAIRE VOMIR. Consulter immédiatement un médecin. Cesser l'utilisation en cas de rougeur ou de démangeaison et laver soigneusement avec de l'eau. Si l'irritation persiste consulter un médecin. SICHERHEITSHINWEISE ZUR VERWENDUNG VON STOFFEN! Kühl und lichtgeschützt lagern, max. 30°C. Nur zur äußerlichen Anwendung. Den Kontakt mit den Augen, nicht schlucken. Bei Berührung mit den Augen mit viel Wasser spülen, ggf. Augen offen halten. Sofort einen Arzt aufsuchen. Bei Verschlucken Mund gründlich mit Wasser ausspülen. Etwas frisches Wasser trinken. KEIN ERBRECHEN HERBEIFÜHREN. Sofort einen Arzt aufsuchen. Bei Rötungen oder Juckreiz die Anwendung abbrechen und gründlich mit Wasser abwaschen. Bei anhaltender Reizung ärztlichen Rat einholen.

Nice S.r.l. Via E. Salgari 10 - 41123 Modena info@nicegroup.it



IT • AVVERTENZA! Parti piccole. Rischio di soffocamento.  
GB • WARNING! Small parts. Choking hazard.  
E • ¡ATENCIÓN! Piezas pequeñas. Peligro de asfixia.  
PT • ATENÇÃO! Peças pequenas. Perigo de asfixia.  
FR • ATTENTION! Petits éléments. Danger d'étouffement.  
DE • ACHTUNG! Kleine Bestandteile. Erstickungsgefahr.

# HEROES!

BRICKS



**78102**

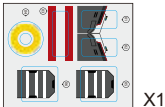
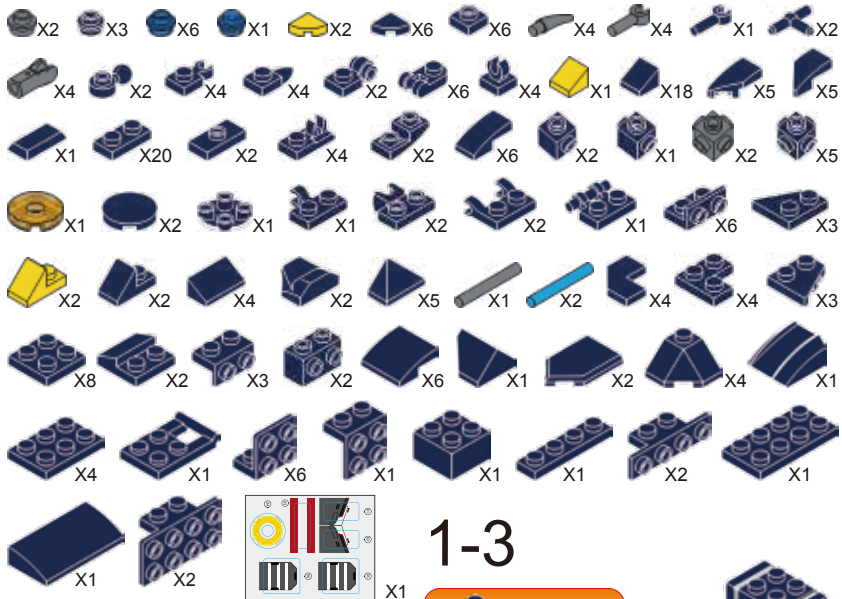

1-3

1-1

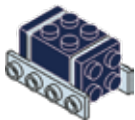
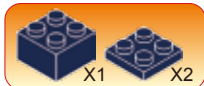
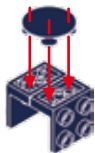

1-4



1-2

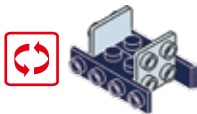

1

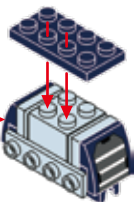

# 1-5

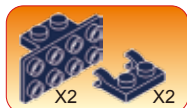

# 1-8

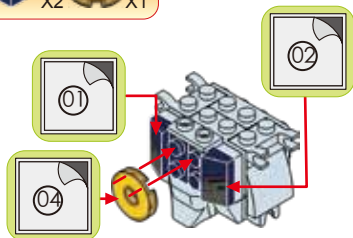

# 1-6

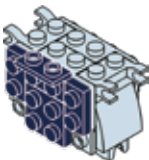

# 1-9

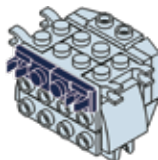

# 1-7

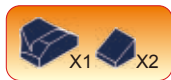

# 1-10

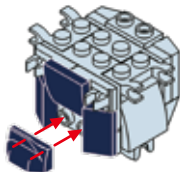

2

# 1-11



# 1-14

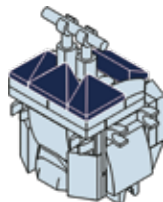

# 1-12

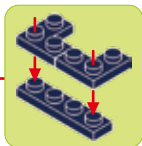
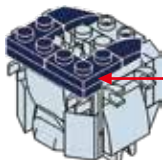

# 1-15

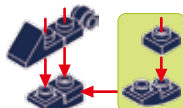

# 1-13

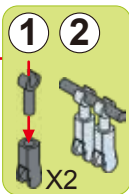
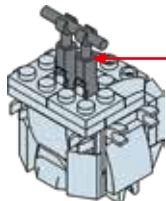

# 1-16

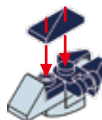

3



# 1-17

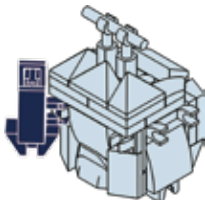

# 1-21



# 1-18

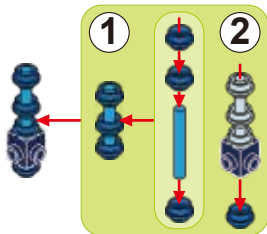
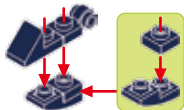

# 1-19

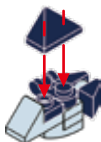

# 1-22



# 1-20

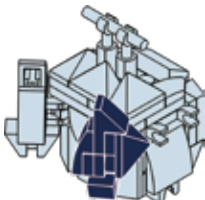

# 1-23



4

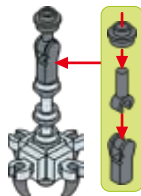

# 1-24

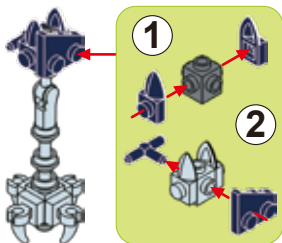

# 1-25

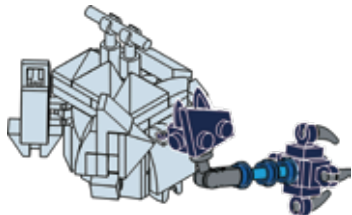

# 1-26

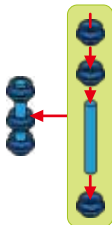

# 1-27

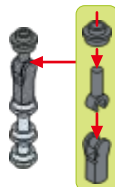

# 1-28

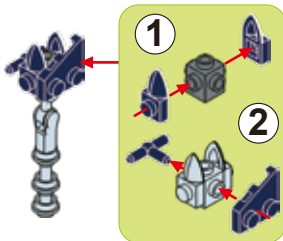

# 1-29

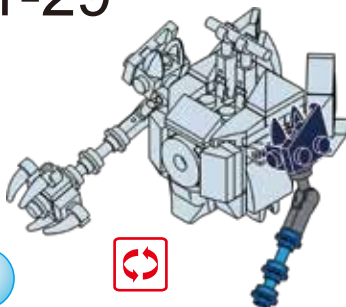

5

# 1-30

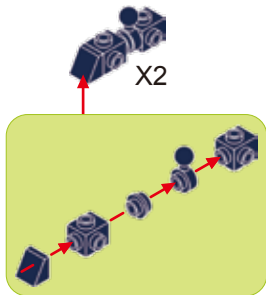

# 1-31

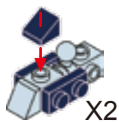

# 1-32



# 1-33

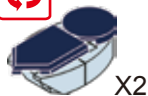

# 1-34

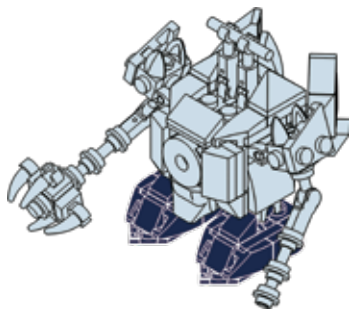

# 1-35

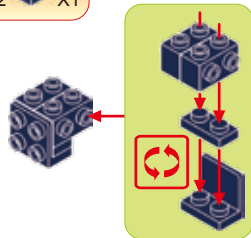

# 1-36



# 1-39



# 1-37

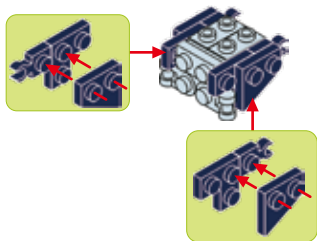

# 1-40

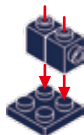

# 1-41



# 1-38

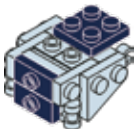

# 1-42

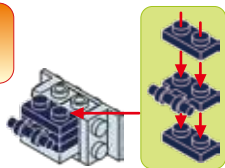

7

# 1-43

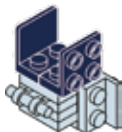

# 1-46

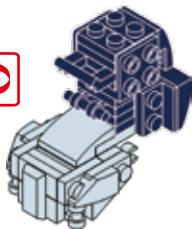

# 1-44

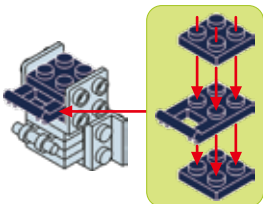

# 1-47

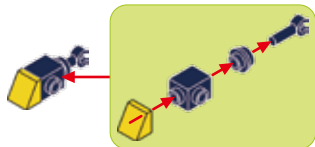

# 1-45

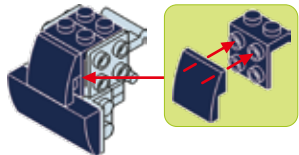
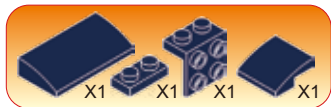

# 1-48

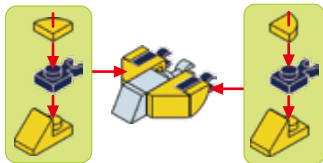

8

# 1-49

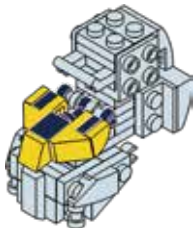

# 1-52

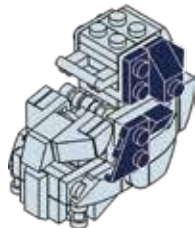
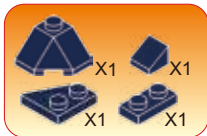

# 1-50

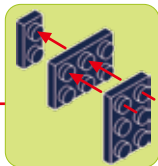
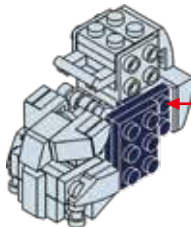
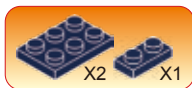

# 1-53

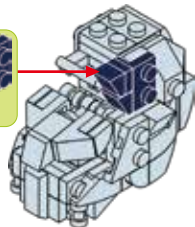
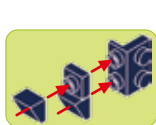

# 1-51

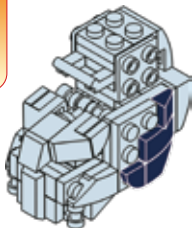

# 1-55

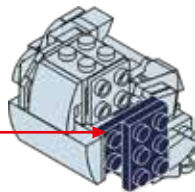
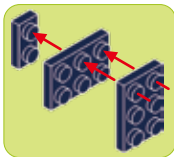
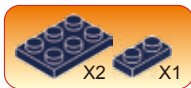

9

# 1-56

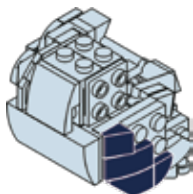

# 1-57

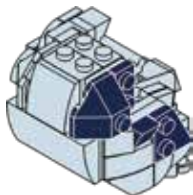

# 1-58

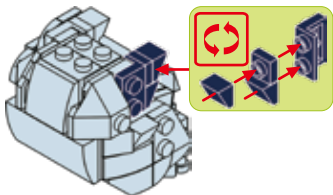

# 1-59

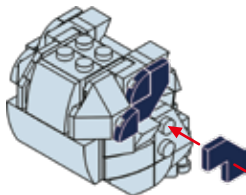

# 1-60

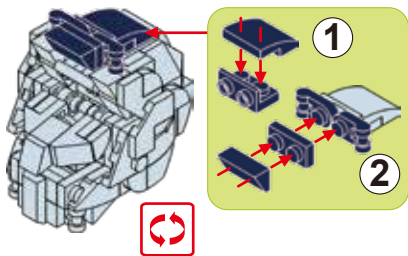
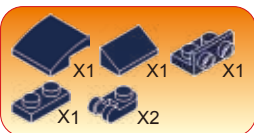

# 1-54

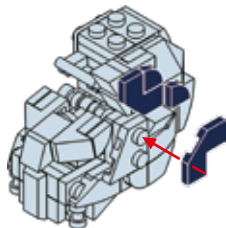

1-60

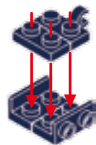
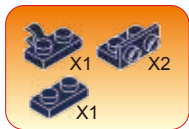

1-64

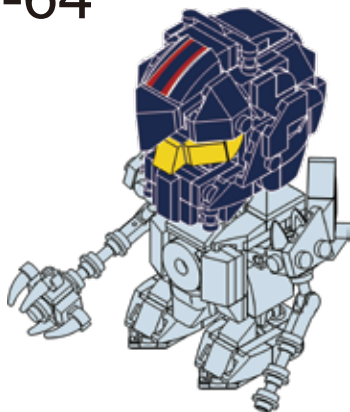

1-61

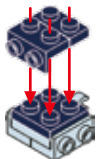
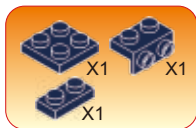

1-62

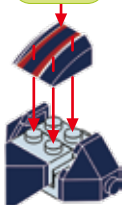

1-65



1-63

